



FREMONT

3/8" SWING DOOR GLASS
SHOWER ENCLOSURE

SPECIFICATIONS

ELEVATION

Option 1 Pivot hinge

Option 2 Pivot hinge with fixed
panel at strike side

SIZE

76" OA Glass Height

GLASS

Page 3

PULLS

Page 5

HARDWARE

Page 6

*Custom sizes available upon request
(6-8 weeks)*



Stacked Finishes: Matte Black ● Polished ● Brushed ●

Available Finishes: Satin Brass ●

**Architectural
Concepts**

O (888) 248 2724
E info@archconceptsllc.com

18505 Longs Way
Parker, CO 80134

archconceptsllc.com

FREMONT SWING SHOWER

GLASS DOOR ELEVATIONS

PIVOT HINGE

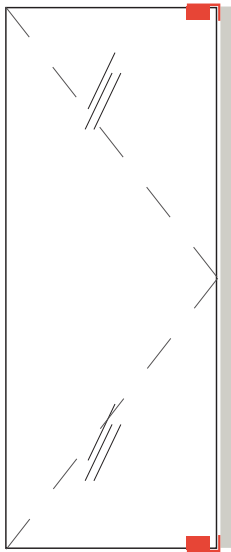

ELEVATION
OPTION 1

PIVOT HINGE WITH PANEL

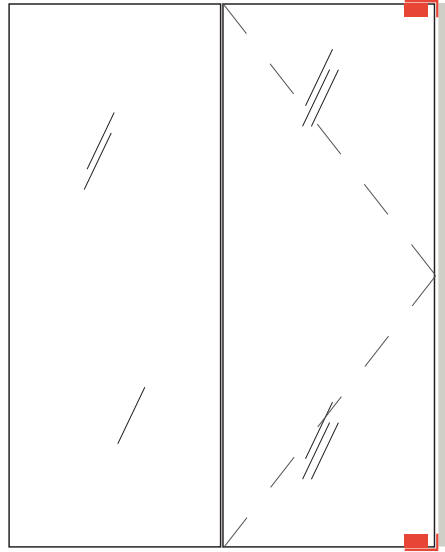

ELEVATION
OPTION 2

GLASS DOOR AND PANEL DIMENSIONS

36" MAX. DOORS

PLAN - OPTION 1

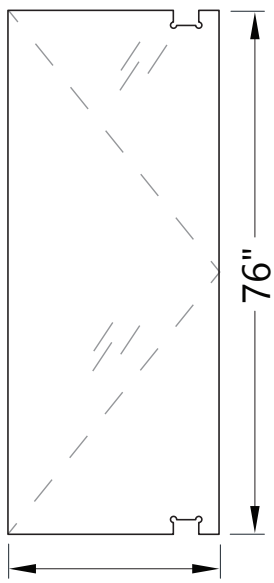

PLAN - OPTION 2

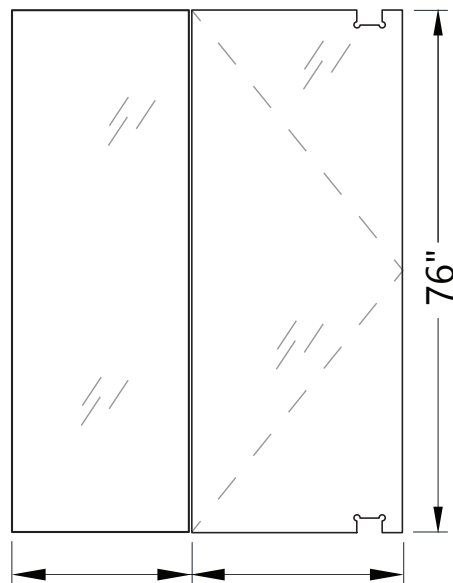

PLAN - OPTION 1

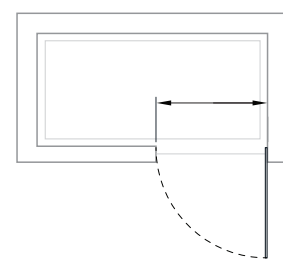

PLAN - OPTION 2

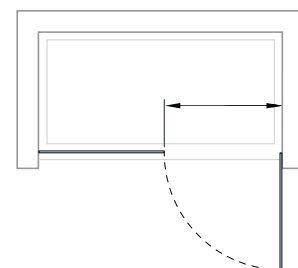

Architectural Concepts

(888) 248 2724 | (720) 259 5358 | info@archconceptsllc.com | 18505 Longs Way, Parker, CO 80134 | archconceptsllc.com

FREMONT SWING SHOWER

SINGLE DOOR - STANDARD HEIGHT 76" OA

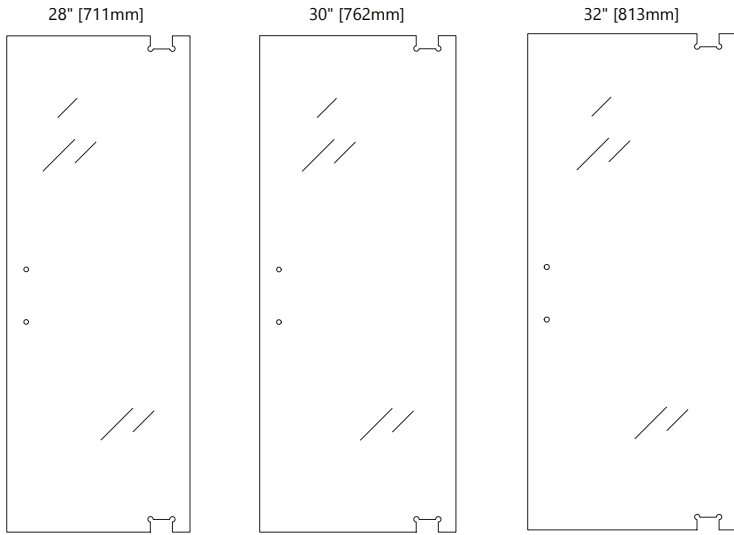

PART #
ACSD-FRE2H028X76

SIZE
28" x 75 9/16"

OPENING WIDTH
31 9/16" x 33 7/16"

PULL SERIES
8x8 MO/HU/RO

PART #
ACSD-FRE2H030X76

SIZE
30" x 75 9/16"

OPENING WIDTH
33 9/16" - 35 7/16"

PULL SERIES
8x8 MO/HU/RO

PART #
ACSD-FRE2H032X76

SIZE
32" x 75 9/16"

OPENING WIDTH
35 9/16" - 37 9/16"

PULL SERIES
8x8 MO/HU/RO

3/8" CLEAR FIXED PANELS

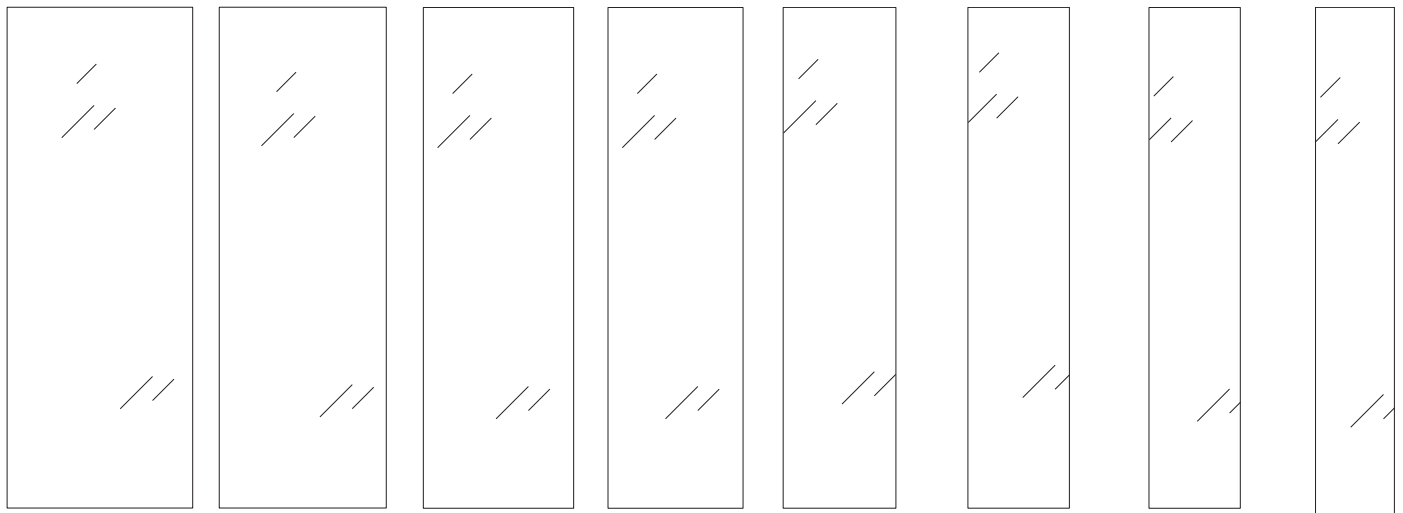

PART #
ACSD-PNL2878X7512

SIZE
28 7/8" x 75 1/2"

PART #
ACSD-PNL2678X7512

SIZE
26 7/8" x 75 1/2"

PART #
ACSD-PNL2478X7512

SIZE
24 7/8" x 75 1/2"

PART #
ACSD-PNL2278X7512

SIZE
22 7/8" x 75 1/2"

PART #
ACSD-PNL1678X7512

SIZE
16 7/8" x 75 1/2"

PART #
ACSD-PNL1478X7512

SIZE
14 7/8" x 75 1/2"

PART #
ACSD-PNL1278X7512

SIZE
12 7/8" x 75 1/2"

PART #
ACSD-PNL1078X7512

SIZE
10 7/8" x 75 1/2"



Architectural Concepts

(888) 248 2724 | (720) 259 5358 | info@archconceptsllc.com | 18505 Longs Way, Parker, CO 80134 | archconceptsllc.com

FREMONT SWING SHOWER

FIT MATRIX 1 1/2" U-CHANNEL (TYPICAL OPENINGS AND NON-STANDARD APPLICATION)

FIXED PANEL GLASS

1 1/2" U CHANNEL PART#
ACUC

PANEL SIZES

- 28 7/8" x 75 1/2"
- 26 7/8" x 75 1/2"
- 24 7/8" x 75 1/2"
- 22 7/8" x 75 1/2"
- 16 7/8" x 75 1/2"
- 14 7/8" x 75 1/2"
- 12 7/8" x 75 1/2"
- 10 7/8" x 75 1/2"

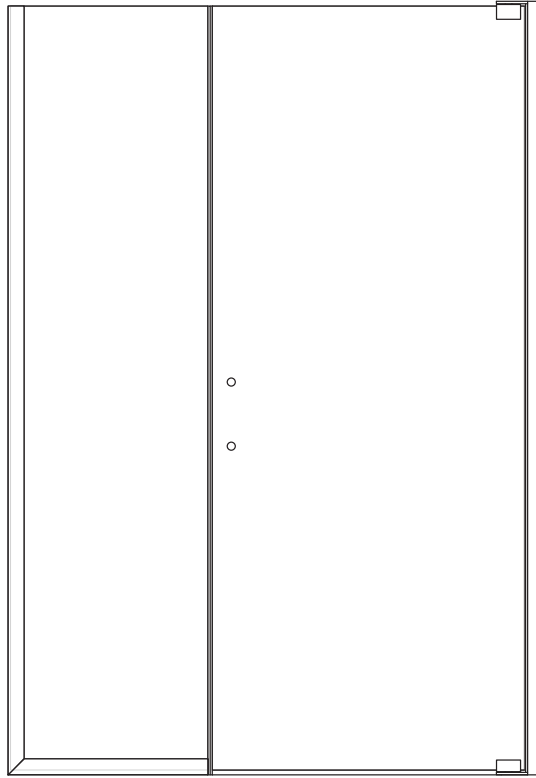

DOOR & PANEL - STOCK OA HEIGHT 76"

OPENING SIZE COMBINATION GROUPS - TYPICAL OPENINGS

DOOR	PANEL	FITS
28"	26 7/8"	57 1/4" - 59 1/4"
30"	24 7/8"	57 1/4" - 59 1/4"
32"	22 7/8"	57 1/4" - 59 1/4"
28"	28 7/8"	59 1/4" - 61 1/4"
30"	26 7/8"	59 1/4" - 61 1/4"
32"	24 7/8"	59 1/4" - 61 1/4"
28"	16 7/8"	47 1/4" - 49 1/4"
30"	14 7/8"	47 1/4" - 49 1/4"
32"	12 7/8"	47 1/4" - 49 1/4"
28"	14 7/8"	45 1/4" - 47 1/4"
30"	12 7/8"	45 1/4" - 47 1/4"
32"	10 7/8"	45 1/4" - 47 1/4"

NON-STANDARD OPENINGS

DOOR	PANEL	FITS
32"	28 7/8"	63 1/4" - 65 1/4"
32"	26 7/8"	61 1/4" - 63 1/4"
32"	16 7/8"	51 1/4" - 53 1/4"
30"	28 7/8"	61 1/4" - 63 1/4"
30"	16 7/8"	49 1/4" - 51 1/4"
30"	10 7/8"	43 1/4" - 45 1/4"
30"	22 7/8"	55 1/4" - 57 1/4"
28"	24 7/8"	55 1/4" - 57 1/4"
28"	12 7/8"	43 1/4" - 45 1/4"
28"	10 7/8"	41 1/4" - 43 1/4"
28"	22 7/8"	53 1/4" - 55 1/4"



Architectural Concepts

(888) 248 2724 | (720) 259 5358 | info@archconceptsllc.com | 18505 Longs Way, Parker, CO 80134 | archconceptsllc.com

FREMONT SWING SHOWER

PULLS

Stocked Finishes: Matte Black ● Polished ● Brushed ●

Available Finishes: Satin Brass ●

Custom finishes available

ACHU8X8



Square Tubing 8" BTB Pull

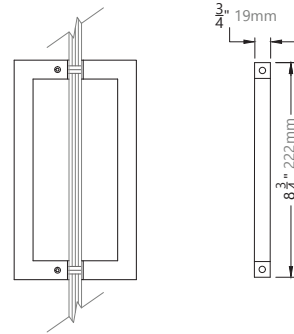

ACM06312



8" CTC Ladder Pull - 12" OA length

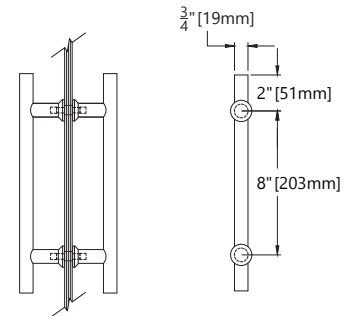

ACR08X8



Tubular 8" BTB Pull

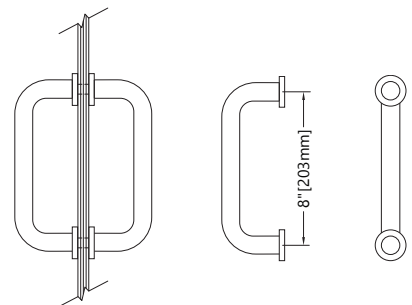

Architectural Concepts

(888) 248 2724 | (720) 259 5358 | info@archconceptsllc.com | 18505 Longs Way, Parker, CO 80134 | archconceptsllc.com

FREMONT SWING SHOWER

HARDWARE

Stocked Finishes: Matte Black ● Polished ● Brushed ●

Available Finishes: Satin Brass ●

Custom finishes available

ACSD-FRE90

Wall-to-Glass Hinge Top & Bottom

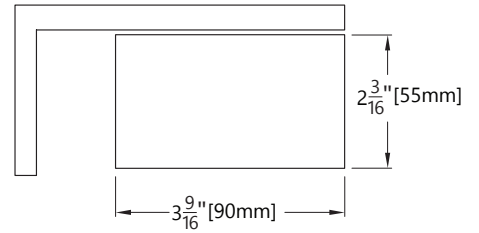
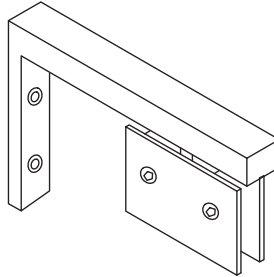

ACUC

1 1/2\"/>

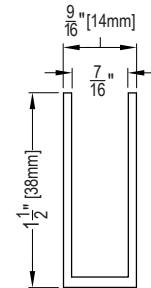
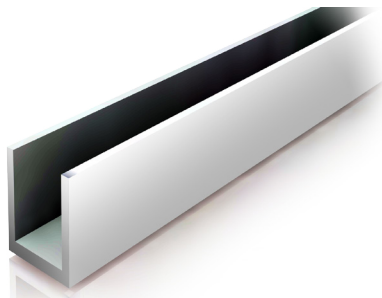

ACSDVS990

Vertical Seal

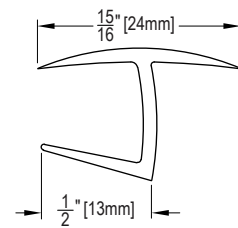

ACSDS990

Bottom Sweep

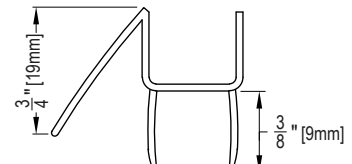

Architectural Concepts

(888) 248 2724 | (720) 259 5358 | info@archconceptsllc.com | 18505 Longs Way, Parker, CO 80134 | archconceptsllc.com