



AC9000A

BARN DOOR HARDWARE

SPECIFICATIONS

Max door weight:
220 lbs

Track length comes in 2 lengths:
2M and 2.5M

Dual-Soft Close:
MINIMUM door size for application is 23 5/8" wide

Available Finishes: Matte Black ● Polished ● Brushed ● Satin Brass ●

Custom finishes available

Architectural
Concepts

O (888) 248 2724
E info@archconceptsllc.com

18505 Longs Way
Parker, CO 80134

archconceptsllc.com

HARDWARE

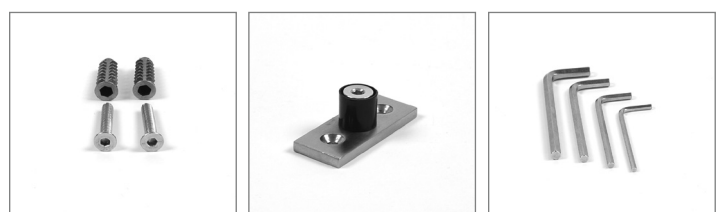



AC9000A

78" BARN DOOR HARDWARE

ELEVATION

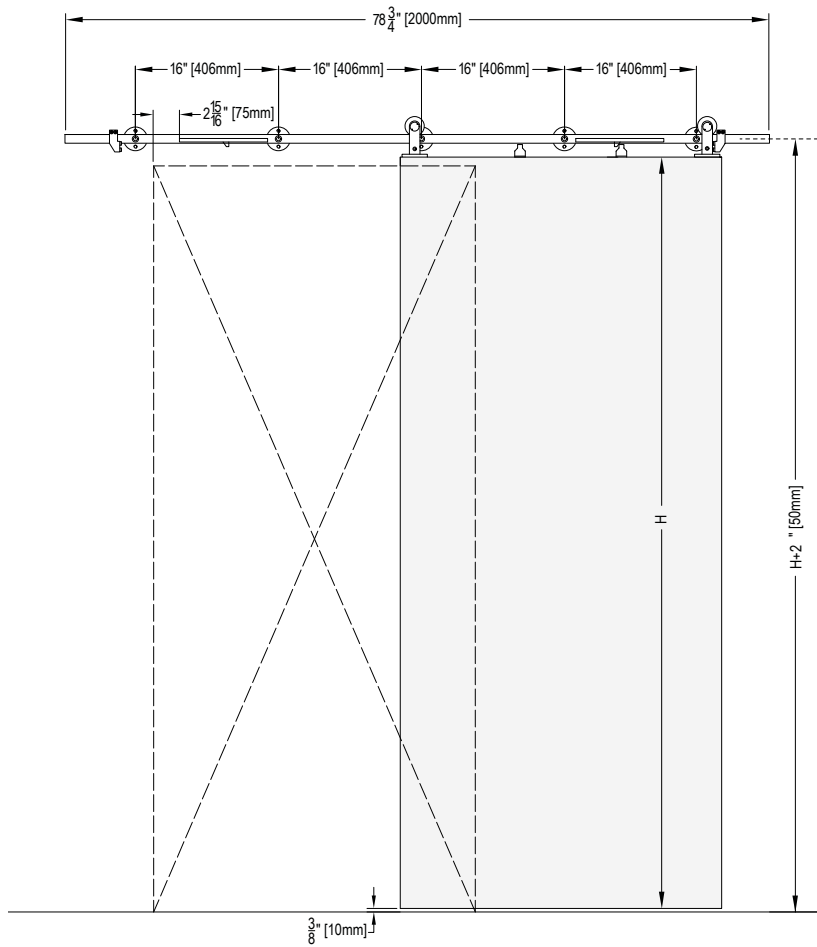

Architectural
Concepts

O (888) 248 2724
E info@archconceptsllc.com

18505 Longs Way
Parker, CO 80134

archconceptsllc.com

HARDWARE FINISH OPTION

Available Finishes: Matte Black ● Polished ● Brushed ● Satin Brass ●

Custom finishes available



AC9000A

98" BARN DOOR HARDWARE

ELEVATION

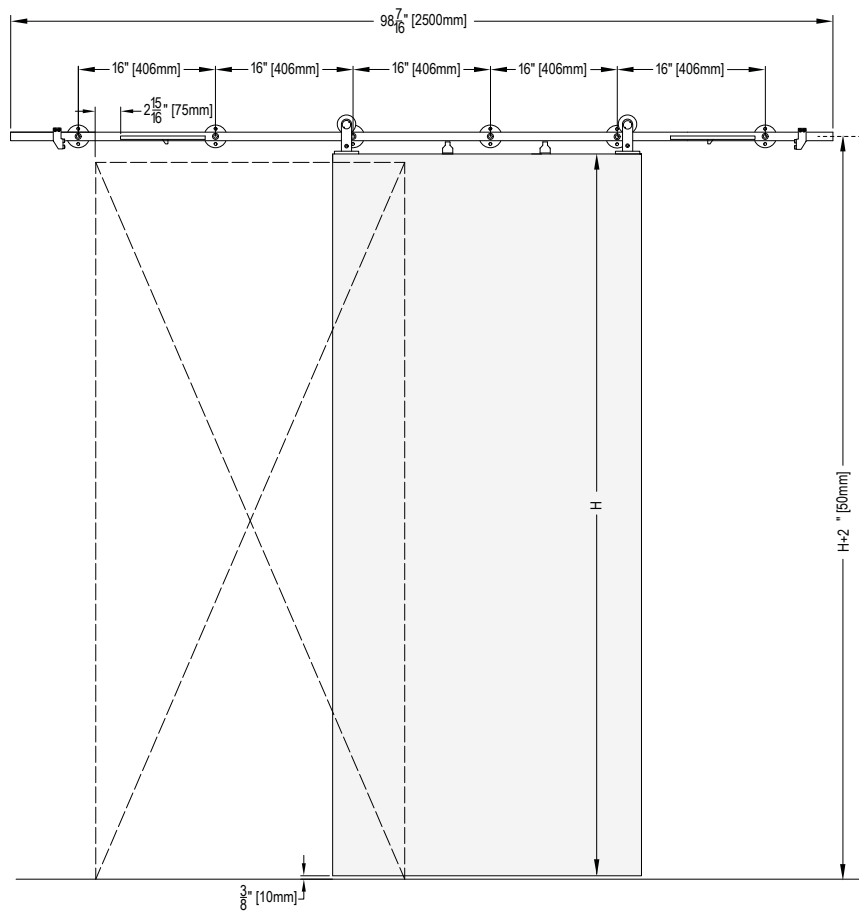

HARDWARE FINISH OPTION

Available Finishes: Matte Black ● Polished ● Brushed ● Satin Brass ●

Architectural
Concepts

O (888) 248 2724
E info@archconceptsllc.com

18505 Longs Way
Parker, CO 80134

archconceptsllc.com

AC9000A

BARN DOOR HARDWARE

HANGER ELEVATION SIDE

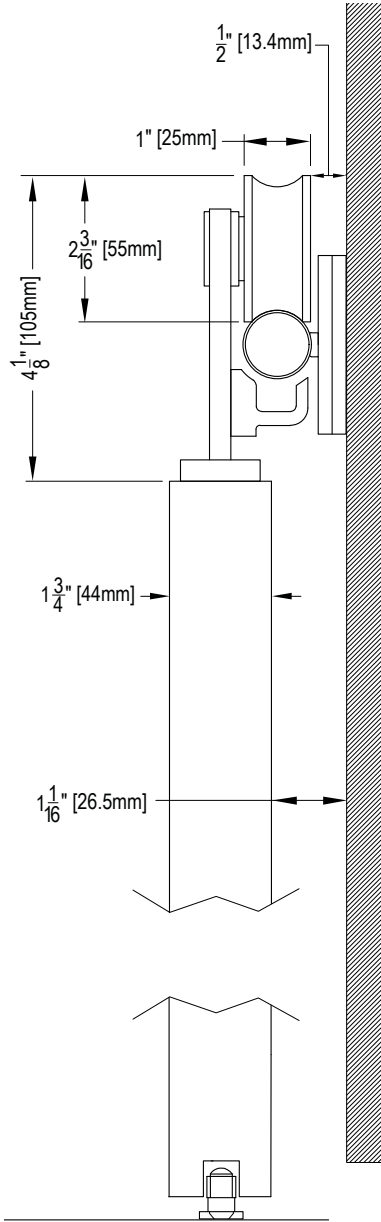

HARDWARE DIMENSIONS

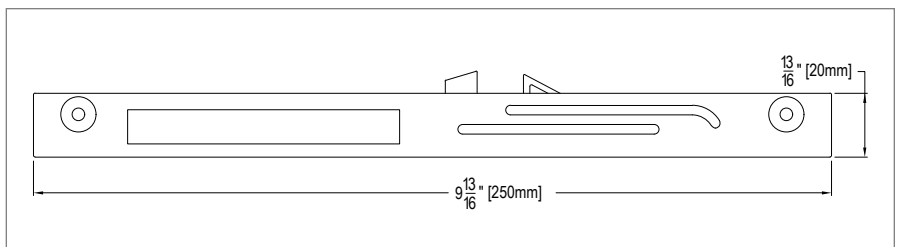
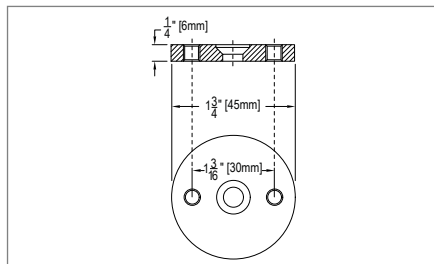
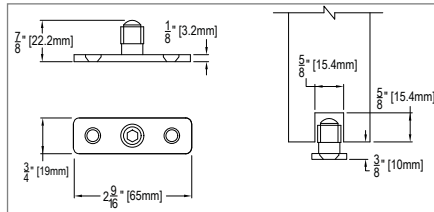
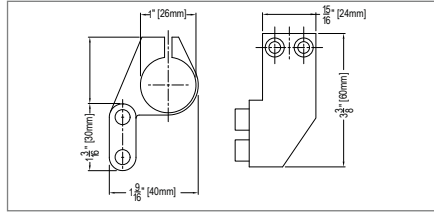
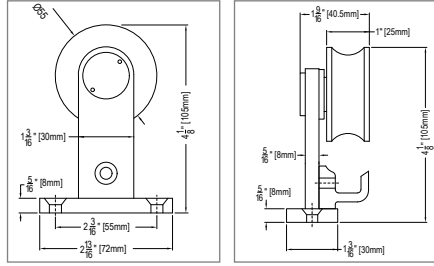

Architectural Concepts

(888) 248 2724 | (720) 259 5358 | info@archconceptsllc.com | 18505 Longs Way, Parker, CO 80134 | archconceptsllc.com