



AC110

DOOR LEVER



SPECIFICATIONS

FINISHES

629 - Polished Stainless
630 - Satin Stainless

SERIES

Deconstructive

MODEL

AC110

FUNCTIONS

PA - Passage
PR - Privacy
DU - Dummy

BACKSETS

2 3/8"
2 3/4"

ROSE OPTIONS

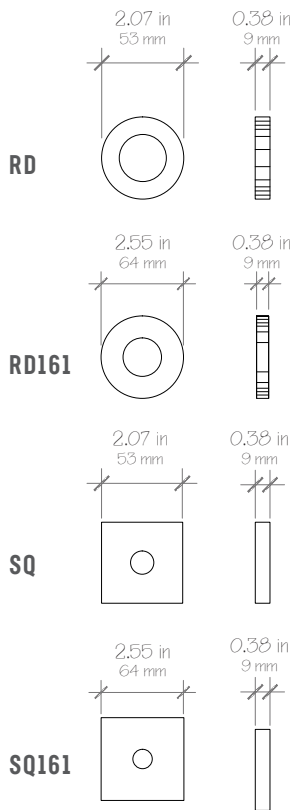

DIMENSIONS

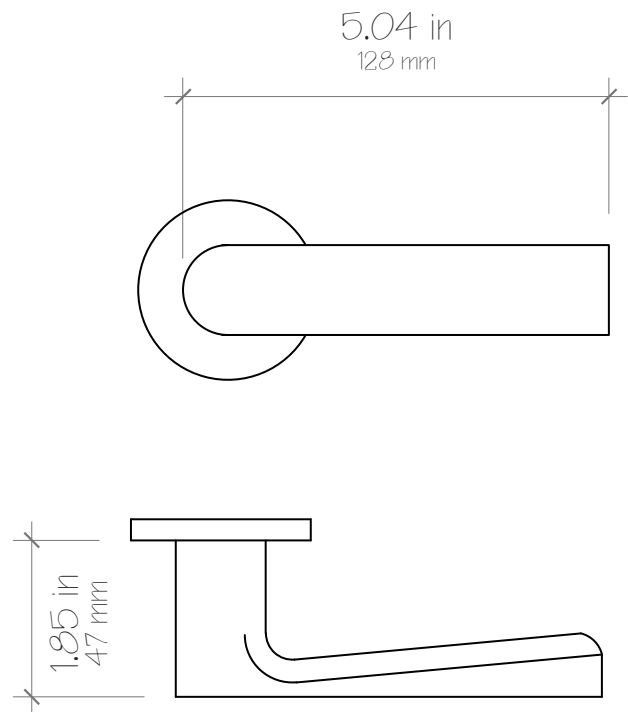

**Architectural
Concepts**

O. 888.248.2724
D. 720.259.5364
E. info@archconceptsllc.com

18499 Longs Way
Suite 102
Parker, CO 80134

NOTE: If installing on an existing 2-1/8" bore, you will need to use the RD161 or SQ161 to cover the face hole properly.

archconceptsllc.com